

Wistom[®]

White Paper Optical Layer Monitoring[™]

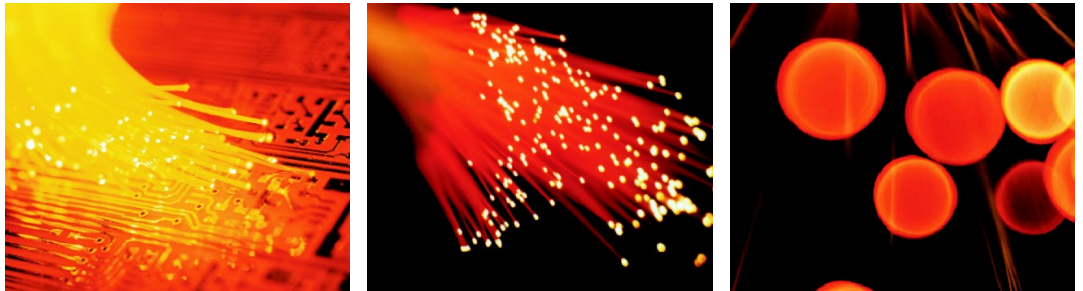

Abstract

In this white paper we will reveal the underlying technology behind Proximion's new ultra-fast, high performance scanning filter. A technological breakthrough providing speed without compromising performance!

You will also learn more about Proximion's technology platform, In-Fiber Intelligence. We will explain how we have managed to take the monitoring of optical communication directly to the core of the fiber itself.

With these findings we can offer the system vendors and service providers a new versatile tool, our Optical Layer Monitoring, suitable for any network application, that ultimately secures the optical communication layer by validating Quality of Service.

About Proximion AB

Proximion Fiber Systems AB is a world-class provider of optical modules and sub-systems based on Fiber Bragg Grating (FBG) technology. By combining these unique optical devices with the truly innovative skills of our team, Proximion contributes to our customers' and partners' success in a variety of markets.

The Role of Optical Layer Monitoring™ in Modern Optical Networks

Optical networks emerged in the beginning of the 70's as a result of advancements in transforming glass into high quality, low-loss fiber optic cables and secondly, because of new technologies used to create semiconductor lasers. At that time, the equipment for transmitting data was more or less found in the optical labs of experimentalists and covered shorter transport ranges at moderate communication speeds.

Over the last 30 years, the technology for transmitting data over fiber optic networks has dramatically improved and evolved into a mature technology platform that capitalizes on the immense transport capabilities of the optical fiber.

With the enormous increase in the requirements for communication bandwidth in recent years, new network topologies have been deployed that cover almost every stage of transport, starting with the sender of data and ending with the receiving party. Commonly found network topologies include office, metro, long-haul, ultra long-haul and submarine; all striving to meet the ever increasing demand for more bandwidth.

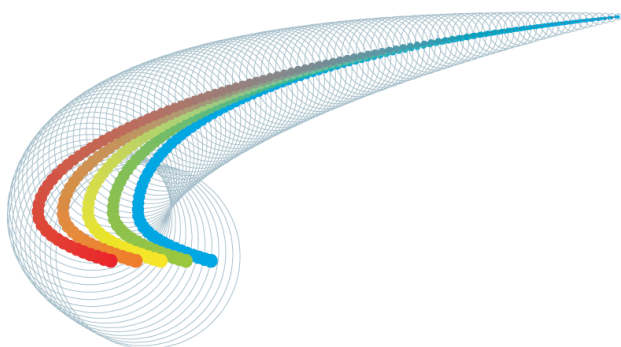

Figure 1 – Wavelength Division Multiplexing. We can fill up the fiber's optical bandwidth by adding communication channels separated from each other by a difference in color.

Instead of installing more fiber into the ground, system vendors have looked into the possibility of lighting up existing fiber by adding more communication channels to each fiber.

This approach is termed wavelength division multiplexing (WDM) and can be described as separating each channel by a unique color, called a wavelength, of the light being transmitted.

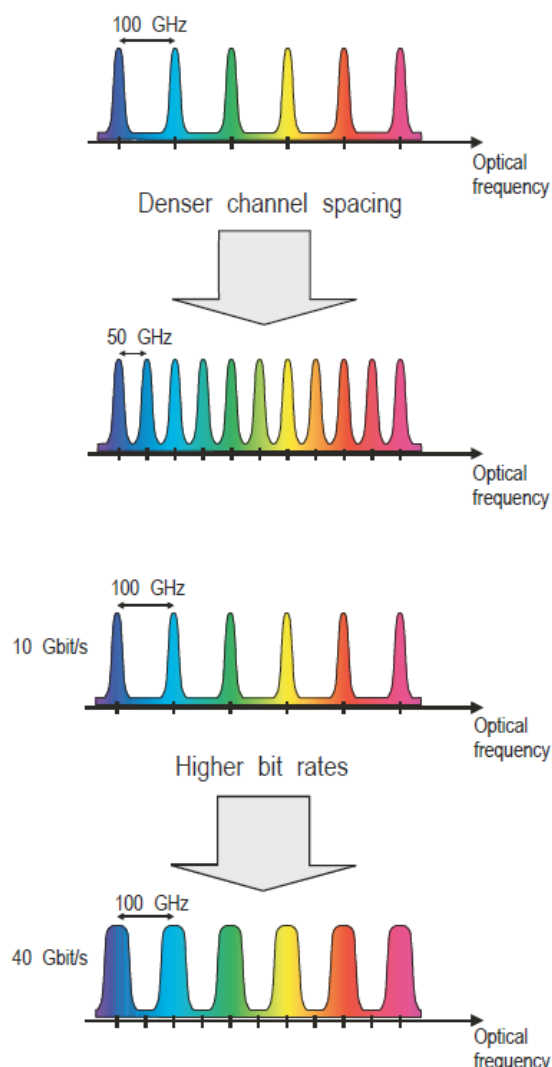

Figure 2 – The trend in telecommunications is to expand a single fiber's bandwidth by packing channels closer together and increasing the data bit rates.

The technology of modern fiber optic networks allows for more than 100 channels to be simultaneously transmitted on a single fiber, at data rates of up to 10 billion bits per second, per channel over long distances. Each fiber can thus accommodate up to one million users surfing the Internet via a high-speed cable-TV modem.

The trend to better utilize the fiber's bandwidth has become apparent as the number of channels grow, channel spacing becomes denser, and the communication speeds increase. This trend, as well as the development toward transmitting data over longer distances without restoration of the optical data, generates a need for monitoring the optical layer in order to ensure the quality of transmission.

As system vendors continuously strive to perfect optical communication equipment, network operator requirements for monitoring and controlling system performance grow. In recent years, numerous applications have emerged where Optical Layer Monitoring (OLM) would be crucial.

OLM stands for accurate measurements of the physical properties of the light being transmitted, e.g. optical power, wavelength, and optical noise. In addition, these measurements should be accomplished in milliseconds. In order to adapt the various types of equipment found in a modern optical network, there is also a need for flexible and highly customizable communications interfaces. Proximion's product WISTOM incorporates all the necessary interfaces and provides OLM based on our innovative scanning filter technology, solving the monitoring tasks at hand

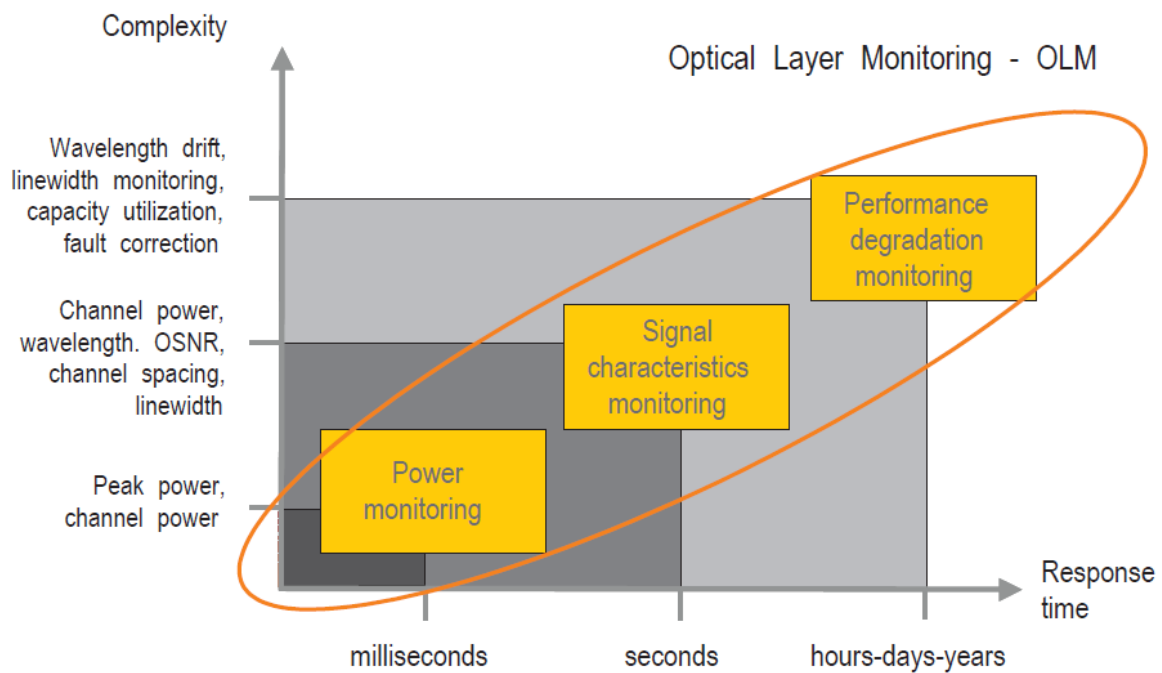

Figure 3 – Modern optical networks demand Optical Layer Monitoring applications that range from standard power monitoring in the millisecond range up to long-term degradation monitoring.

The Need for Speed

From a system vendor's or service provider's perspective, there is a high degree of diversity in individual features and applications, when comparing the numerous types of system equipment used for optical communication. Dissecting the basic elements of Optical Layer Monitoring, a scanning filter device should meet three simple requirements

- Fast scan time
- Narrow filter bandwidth
- High side-mode suppression

When we built our optical layer monitor around a fast-scanning filter that covers all communication channels, a wide number of applications relying on a quick feedback loop from the monitoring system emerge. Examples of such applications that benefit from a fast response time in milliseconds are protection switching and dynamic gain equalization.

Utilizing a scanning device with a narrow filter bandwidth makes the optical layer monitor ideal for high-channel count systems. A narrow filter bandwidth in combination with high side-mode suppression, allows for accurate and precise performance measurements of the optical layer.

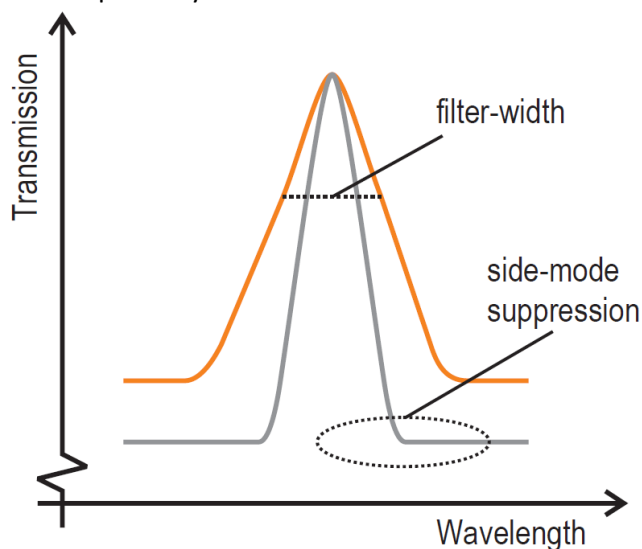

Figure 4 – Depicted in grey/orange, a narrow/wide transmission filter width and high/low side-mode suppression.

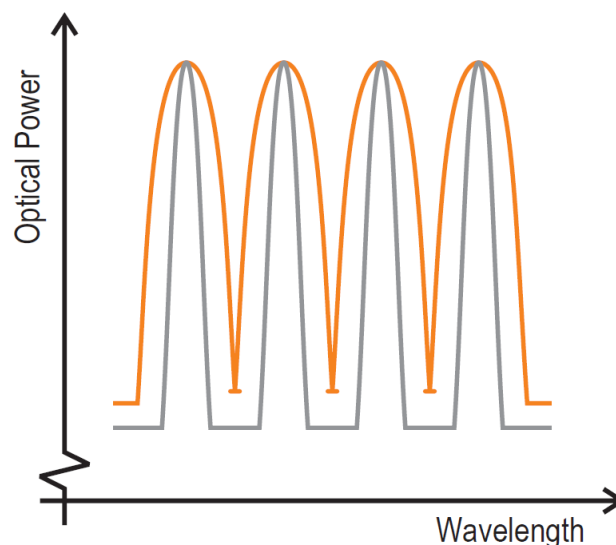

Figure 5 – Depicted in grey/orange, optical DWDM channels monitored with a narrow/wide transmission filter. Note the higher level of detail the narrow filter provides.

Customers selecting devices with these three parameters in mind have guaranteed that their monitoring system will be well equipped for the future, i.e. that channel spacing tends to decrease and the number of channels increase.

When these three parameters are combined into one single scanning device and integrated with a flexible and customizable hardware platform, you have a monitoring unit that suits almost any application and fits in all layers of the fiber optic communication network.

In-Fiber Intelligence™

In order to produce a scanning filter device that meets the high demands of today's and future network monitoring needs, Proximion takes the technology to the core of the fiber, i.e. directly to the optical layer itself. Proximion coined this unique process "In-Fiber Intelligence".

Proximion's scanning device utilizes a patented new technology for generating an ultra-fast, high-performance filter. This is accomplished by opening up a very narrow transmission window of an otherwise very broadband, highly reflective fiber Bragg grating (FBG).

To the Core

A fiber Bragg grating can, in its simplest context, be seen as an optical filter where a part of the incident light is either being transmitted or reflected. Since the grating is written in the actual core of the fiber it interacts with the light being transmitted.

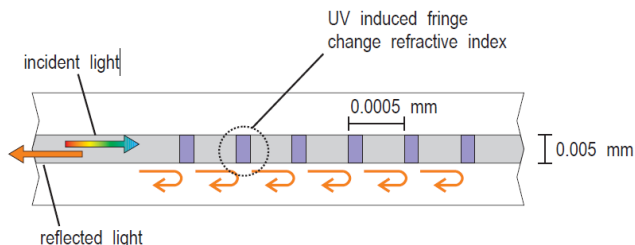

Figure 6 – A view of the ultraviolet fringe pattern induced in the core of the fiber. The distance between the fringes controls what wavelength is reflected, e.g. 500 nm would typically reflect wavelengths close to 1500 nm.

A grating is generated by exposing the core, typically no more than 5 μm in diameter (i.e. a tenth of the diameter of a normal human body-hair) of a specially prepared optical fiber to a fringe pattern of ultraviolet light. The ultraviolet light will locally induce a change in the refractive index of the core. A change in refractive index, even a small change, will be seen as a tiny mirror by the light trying to pass through the grating, and a small portion will be reflected. By generating many of these local mirrors in sequence at well-defined distances, an optically resonant cavity is produced. By tuning the distance and amplitude between the mirror elements, the filter characteristics (e.g. the wavelengths and amount of reflected light) can also be tuned.

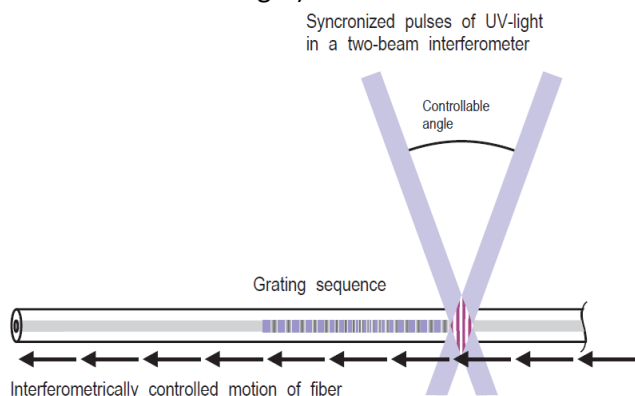

Figure 7 – Two ultraviolet laser beams interfere, resulting in a fringe pattern. By accurately controlling the motion of the fiber many successive fringe patterns can be added into very long gratings.

Proximion's versatile and unique grating writing technology utilizes a two-beam interferometer to

create a fringe pattern of ultraviolet light used for inducing the change of refractive index to the core of the fiber. A highly accurate motion controller can sequentially add up these fringe patterns with nanometer precision over hundreds of millimeters. By actively controlling the period of the fringe pattern and adding a dithering mechanism, any type of filter can be generated for almost any application.

The grating characteristics such as wavelength range, reflection, side-mode suppression and dispersion compensation are easily changed with a few keystrokes on the controlling computer.

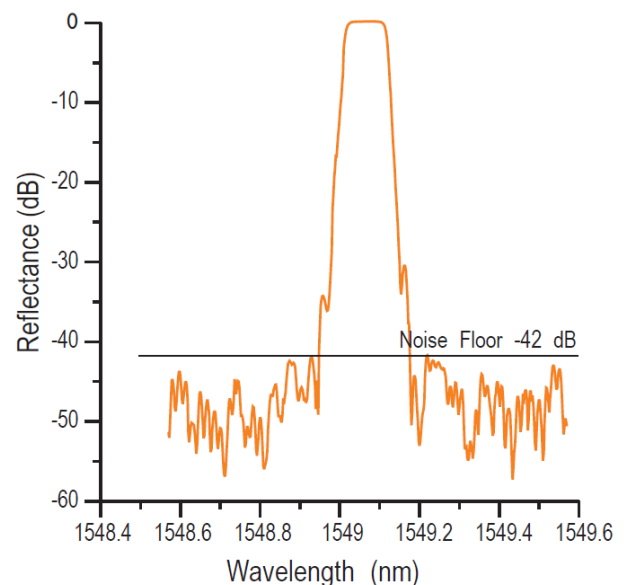

Figure 8 – Example of a 30 mm long, chirped, and apodized fiber Bragg grating manufactured by Proximion. Notice the flat top, steep edges and high side-mode suppression -42 dB.

The Scanning Filter

The light being monitored is first tapped off the main transmission line and fed to the hermetically sealed scanning device. While inside, it is first passed through an optical circulator that directs the light towards a broadband fiber Bragg grating reflecting only the optical spectrum of the communication channels (e.g. the C-band) to be analyzed. This pass-band filter thus rejects (transmits) any stray light and channels outside the communication band present on the transmission line. The reflected and filtered light, once again, passes through the circulator, this time directing the light towards the scanning filter.

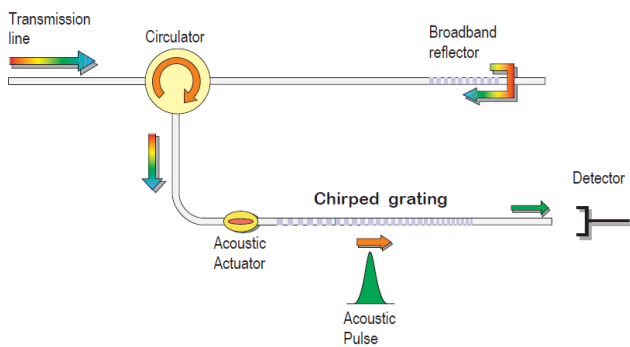

Figure 9 – Scanning filter building blocks; broadband reflector, acoustic actuator and a chirped fiber Bragg grating.

The scanning filter is comprised of two main building blocks

- An acoustic-optic actuator device
- A chirped fiber Bragg grating

An electronic signal generator drives the acoustic actuator that launches a short, longitudinal acoustic pulse into the core of the fiber. The pulse traverses the fiber at a great speed and passes over a long, chirped fiber Bragg grating. The chirped grating is characterized by being reflective for a certain wavelength at a well-defined position along the grating.

As the acoustic pulse passes over the grating, a local and superimposed disturbance of the core's refractive index is established. By generating a disturbance of well-known character, a narrow transmission window with high sidemode suppression is created to allow a certain wavelength to pass through the grating. As the pulse moves over the chirped grating, the center wavelength of the transmission window is shifted, and a scan is performed.

The speed with which the acoustic pulse traverses the grating is incredibly fast. One single scan over the entire communication band is performed in less than 100 μ s! If we were to connect an optical fiber between the cities of London and Paris, the acoustic pulse would cover that distance in no more than 60 seconds. Furthermore, the acoustic pulse would outrun a F16 fighter jet flying at Mach 2 by a factor of eight.

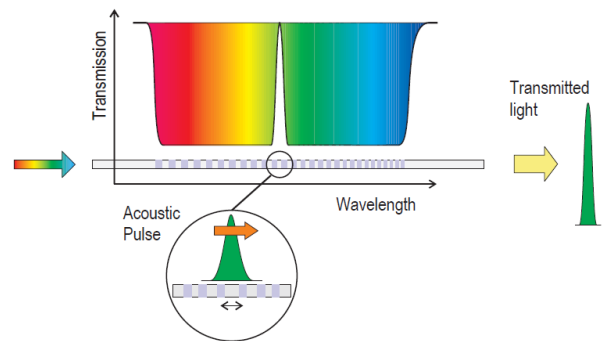

Figure 10 – When the acoustic pulse passes over a chirped fiber Bragg grating and locally disturbs the refractive index, a narrow transmission window is created.

A fast detector and analog-to-digital converter is continuously monitoring the amplitude of the optical signal transmitted through the scanning filter. The optical signal is converted to the electrical domain, amplified and stored in data memory for further data processing.

When the high-detailed filter is actively scanning, it generates a real-time stream of spectral data exceeding 300 million data bits per second! In order to take full advantage of these data streams, the filter needs a fast hardware platform to retrieve and process its data in real-time. Doing so accomplishes two important tasks at the same time; it provides both speed and spectral performance using the same monitoring device.

WISTOM is Proximion's Optical Layer Monitoring platform.

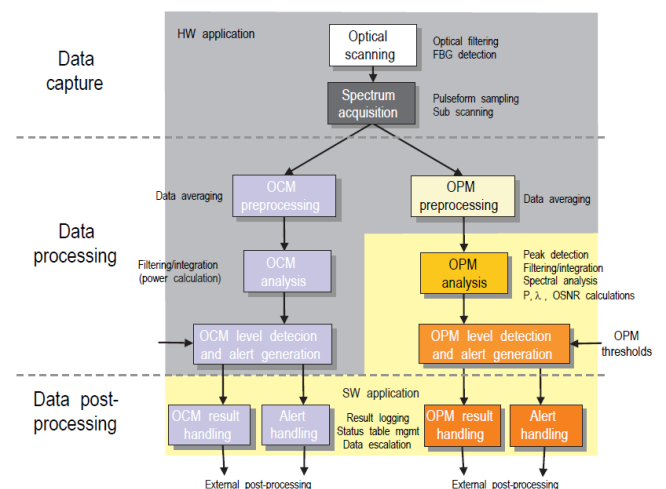

Figure 11 – The WISTOM platform divides the data stream into two parallel and truly independent processes. This provides for simultaneous OPM and OCM monitoring.

One Unit Any Application

By using WISTOM, a telecommunication network or element management (TNM or EMS) system can control the optical network nodes and tune the optical network parameters. As an example, by exchanging information, these systems can switch traffic to different wavelengths alternatively re-route the traffic to a different fiber or adjust the power level for each individual wavelength. These nodes operate in both metro rings and in long-haul/ultra-long-haul networks.



Figure 12 – Proximion’s Optical Layer Monitor WISTOM.

The monitoring can be applied to complex channel plans containing line grids with variable spacing at both low and very high dense channels. The continuous full-spectrum, real-time channel monitoring of WISTOM ensures an effective scanning of all relevant optical parameters. Thus, the WISTOM unit acts as an all-in-one monitor for the optical layer.

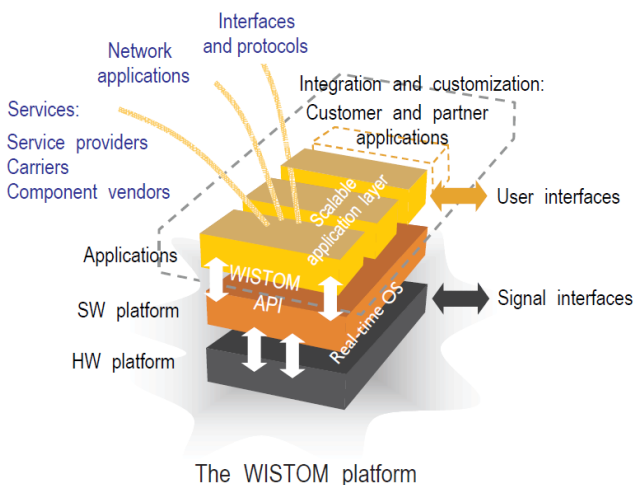

Figure 13 – A schematic view of the WISTOM platform; applications (top), SW platform (middle) and HW platform (bottom).

Power Level Detection

WISTOM can monitor the optical power of each channel and simultaneously analyze and detect faults in the optical spectrum. This monitoring can be applied to complex channel plans containing line grids with variable spacing at both low and very high dense channels. Related to this are different protection/restoration techniques (fault management) in case of a channel failure. WISTOM is perfectly suited for these applications as its real-time hardware platform in combination with state-of-the-art signal processing algorithms generate power alerts with a response time in milliseconds.

Protection Switching

To avoid data loss, protection switching is a fundamental requisite in optical networks. The signal for a failing channel has to be given within milliseconds, enabling the network to correct itself in real-time before service-affecting information loss occurs. This allows hot-swap (automatic, non-interruptive protection switching) and similar network reconfigurations to be applied. Service restoration in case of a fiber cut can be made transparent to the user.

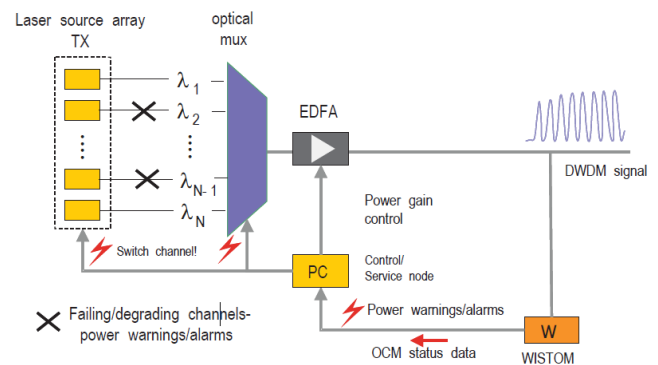

Figure 14 – WISTOM in a power monitoring application.

Dynamic Gain Equalization

Power monitoring capability in DWDM equipment is necessary to maximize amplification in the fibers. When fiber and other optical components age, their characteristics change, resulting in a shift of the optical gain/tilt. Variable output amplifiers can strengthen the multiplexed optical signal to enable it to be transmitted for long distances in the fiber without degradation. Fast and precise channel power estimates from WISTOM's monitoring data are used as an input to both optical amplifiers (EDFAs) and laser diode transmitters for controlling the channel gains and balancing the optical power.

Optical Performance Monitoring

WISTOM Optical Performance Monitoring (OPM) is a non-intrusive capability carried out in the all-optical domain. This makes it inherently protocol and bit-rate transparent, supporting all data rate and framing formats. The full spectrum OPM scanning of power, wavelength and optical signal/noise ratio (OSNR) is deployed in real time.

OADM Supervision

The optical add-drop multiplexer (OADM) is a switching element used to manage wavelengths. There is often a change in the output power as channels are dropped or inserted in an OADM node or optical cross-connect (OXC). The OXC performs wavelength cross-connect. To prevent disturbances, the network needs to be rebalanced by dynamically changing the channel loading. These power balancing and gain tilt adjustments can provide for effective channel equalization.

Reconfigurable OADMs (R-OADM) are important components for deploying dynamic DWDM systems in ring architectures. By quick reconfiguration of wavelengths, carriers can dynamically provision their networks and open up new opportunities for revenue.

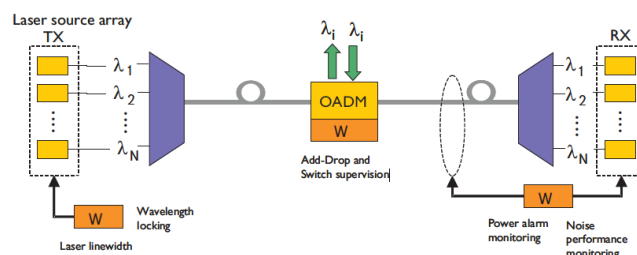

Figure 15 – WISTOM applications in a metro ring network.

Drift Tracking

The increasing complexity in optical communication networks makes it more important to monitor parameter drift. Selected channel quality parameters can be sampled and recorded over time. Thereby, degradations become evident and balancing countermeasures can be applied. Also, performance data can be used to anticipate requirements for network growth/augmentation.

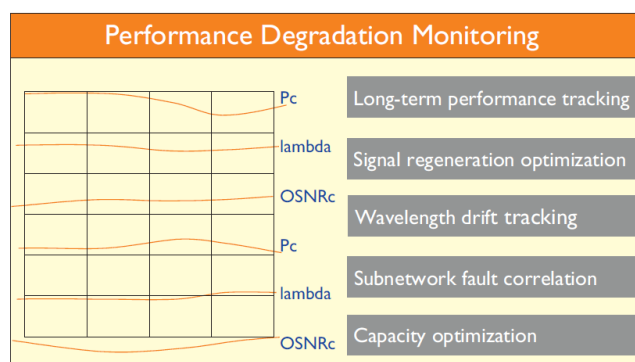

Figure 16 – WISTOM tracking the drift of the optical network.

Summary

Proximion's scanning filter utilizes a patented new technology for generating an ultra-fast, high-performance filter. Without using any moving parts, the filter provides high detail along with an unprecedented scanning time of less than 100 μ s.

Proximion's expertise in producing advanced fiber Bragg gratings has played an important role in the development of this new and innovative scanning filter design. The technology operates in the core of the optical fiber, i.e. directly on the optical layer itself, and is therefore an ideal solution for Optical Layer Monitoring

Proximion's high performance optical layer monitor, WISTOM, continuously scans the optical network layer generating a data stream, depicting the status of the optical layer, exceeding 300 million data bits per second. A state-of-the-art real-time hardware and software platform retrieves and processes the data stream immediately, providing instantaneous monitoring of all necessary optical performance parameters. Two parallel and independent processes simultaneously handles both optical performance and channel monitoring. WISTOM effectively analyzes any channel plan, independent of channel grid and modulation speed. The continuous full-spectrum, real-time monitoring ensures effective supervision of any WDM optical network.

